

**TECHNICAL SPECIFICATIONS:**

	<b>W/flasher</b>	<b>R65</b>
Voltage:	Multivoltage (10-30V)	Multivoltage (10-30V)
Number of LEDs:	3 x 2 W	3 x 2 W
Average consumption:	0.4 A	0.4 A
Average consumption (flashing mode):	0.4 A (blue, white and green) 0.2 A (amber and red)	0.4 A (blue, amber) 0.3 A (red)
Flash patterns:	8 + steady burn	R65 + 7 + steady burn
Weight:	80 gr	80 gr
Dimensions:	106 x 46 x 25 mm	106 x 46 x 25 mm

**HOW TO ORDER**

Choose references from below:

**Smooth and fresnel V15 lens w/ flasher**

2010573	Microled Advance LED directional light, master/slave, 3 LEDs of 2W, amber light, amber smooth lens, w/flasher, multivoltage
2010580	Microled Advance LED directional light, master/slave, 3 LEDs of 2W, amber light, amber Fresnel V15 lens, w/flasher, multivoltage
2010574	Microled Advance LED directional light, master/slave, 3 LEDs of 2W, amber light, clear smooth lens, w/flasher, multivoltage
2010581	Microled Advance LED directional light, master/slave, 3 LEDs of 2W, amber light, clear Fresnel V15 lens, w/flasher, multivoltage
2010570	Microled Advance LED directional light, master/slave, 3 LEDs of 2W, blue light, blue smooth lens, w/flasher, multivoltage
2010578	Microled Advance LED directional light, master/slave, 3 LEDs of 2W, blue light, blue Fresnel V15 lens, w/flasher, multivoltage
2010571	Microled Advance LED directional light, master/slave, 3 LEDs of 2W, blue light, clear smooth lens, w/flasher, multivoltage
2010579	Microled Advance LED directional light, master/slave, 3 LEDs of 2W, blue light, clear Fresnel V15 lens, w/flasher, multivoltage
2010576	Microled Advance LED directional light, master/slave, 3 LEDs of 2W, red light, clear smooth lens, w/flasher, multivoltage
2010575	Microled Advance LED directional light, master/slave, 3 LEDs of 2W, red light, red smooth lens, w/flasher, multivoltage
2010577	Microled Advance LED directional light, master/slave, 3 LEDs of 2W, green light, clear smooth lens, w/flasher, multivoltage
2010572	Microled Advance LED directional light, master/slave, 3 LEDs of 2W, white light, clear smooth lens, w/flasher, multivoltage

**Spread R65 lens**

<b>R65</b>	2010595	Microled Advance LED directional light, master/slave, 3 LEDs of 2W, white light, amber spread lens, multivoltage
<b>R65</b>	2010596	Microled Advance LED directional light, master/slave, 3 LEDs of 2W, blue light, blue spread lens, multivoltage
<b>R65</b>	2010597	Microled Advance LED directional light, master/slave, 3 LEDs of 2W, blue light, clear spread lens, multivoltage
<b>R65</b>	2010598	Microled Advance LED directional light, master/slave, 3 LEDs of 2W, red light, clear spread lens, multivoltage
<b>R65</b>	2010599	Microled Advance LED directional light, master/slave, 3 LEDs of 2W, red light, red spread lens, multivoltage

**Mount Accesories\***

2010230	Surface mount kit, (2) joints, (surface mount)
2010231	Flush mount kit, (2) joints, (flush mount)
2010279	L Bracket for permanent mounting
81523056	Fixation platen, 1 Microled Advance**

\* Choose a mounting kit when ordering  
 \*\*(should be folded by the installer)





**MICROLED ADVANCE Series**  
 LEDs lights

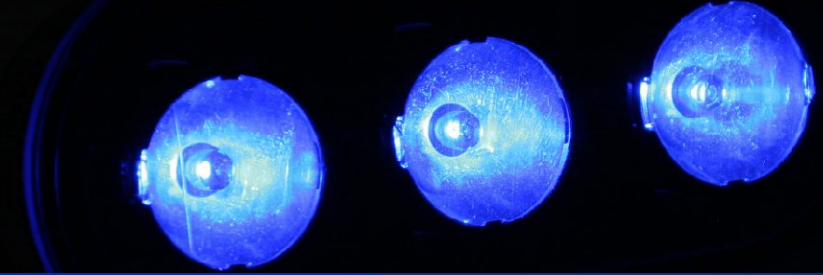

# Microled Advance Series



**Federal Signal Vama** is pleased to announce the introduction of the new Microled Advance supplemental warning LED light. This new addition to Microled range offers additional features and security on emergency situations, and could be installed in almost every place of all emergency vehicle types: rear deck, rearview mirrors, grilles, bumpers, etc. Its main features are:

-  **HIGH INTENSITY.** An ultimate technology LED lights and lenses provide efficient distribution of warning power. Microled Advance offers maximum optical performance with minimal amperage draw.
-  **LONG LIFE.** Federal Signal Vama's LED technology guarantees a long warning light life, helps to reduce maintenance costs, and increases vehicle rotation.
-  **EVERY NEED SOLUTIONS.** Easy to install and with a wide range of solutions: multivoltage references, blue, amber, red or clear lenses, with or without flasher, etc.
-  **WATERPROOF HOUSING.** High density silicone rear sealed, avoiding dust and / or water penetration inside the circuit board. IP protection grade IP9K.

### Approvals

Blue, amber and red lights satisfy R65 European Directive. All models satisfy Electromagnetic Compatibility Directive 2004/104. With IP protection IP9K.



Available colours:

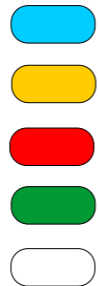

Wide product range



Maximum light intensity.

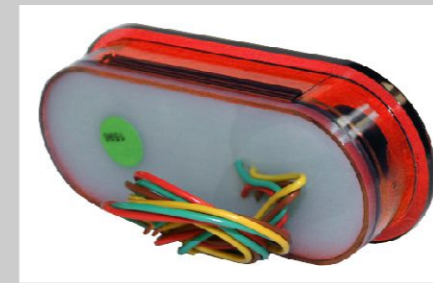

Silicone sealed guarantees no dust and water inside the warning light.



Special Fresnel V15 lens for a light beam inclination, installed on the upper part of the vehicle.



Special spread lens in blue, amber and red, following UN R65 European directive.

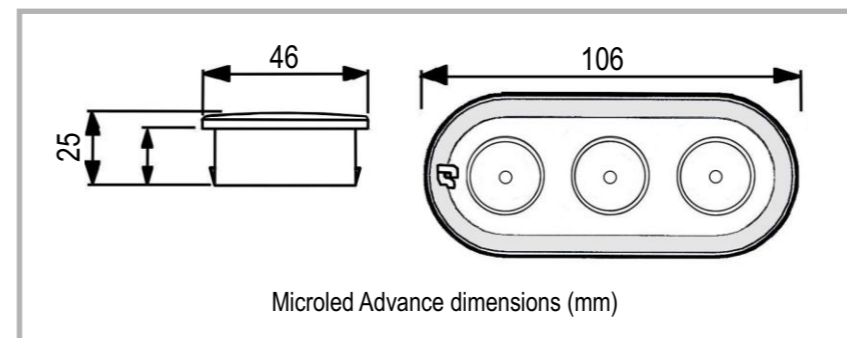

MicroLed Sputnik



MicroLed Advance



MicroLed Advance and Sputnik have fully interchangeable electrical connections for an easy installation.

### INSTALLATIONS OPTIONS



Its easy installation and small measurements allow new Microled Advance to work on a undercover emergency situations.



Increased security on the rear part of the vehicle on emergency situations.